



Ste

**CATALOGUE**  
ET  
**TARIFS**  
DE  
**LOCATION**

**2023**

# SOMMAIRE



**2**

NOTRE ÉQUIPE !

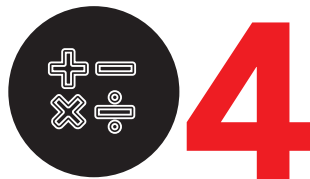

**4**

COEFFICIENTS ET  
CONDITIONS

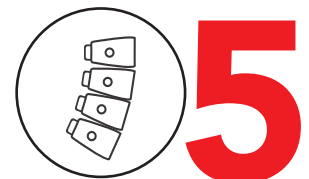

**5**

SONORISATION



**14**

LUMIÈRES



**25**

VIDÉO



**29**

EFFETS SPÉCIAUX



**35**

SCÈNE ET STRUCTURE



**46**

ACCROCHE ET LEVAGE



**47**

DISTRIBUTION ÉLECTRIQUE



**48**

BAR À VINYLES



**49**

DIVERS



**50**

CONSOMMABLES



NOUVEAUTÉ 2023  
**ICONE « AUGMENTATION DES STOCKS ! »**

Grâce à ce symbole, visualisez simplement et rapidement les produits ayant bénéficié d'une augmentation de stock par rapport à l'année 2022.

**1**

 02.50.50.50.82

*Ste*

 [contact@solutiontechniqueevenement.com](mailto:contact@solutiontechniqueevenement.com)





# NOTRE ÉQUIPE

« Passionnée par son métier et véritable famille, l'équipe S.T.E s'attache à répondre avec convivialité et écoute à l'ensemble de vos projets audiovisuels. »



**Marius Robledo**

Direction générale  
06.21.13.47.93



**Adrien Sebire**

Chargé de développement  
06.67.45.51.47



**Damien Derivière**

Direction technique  
06.83.22.63.16



**Teddy Lefranc**

Communication & Logistique  
06.46.55.57.23



## DÉPANNAGE D'URGENCE

**24H/24 7J/7**

Dans le cadre de vos  
contrats de location,  
vous pouvez nous joindre au

**02 50 50 50 82.**



### HORAIRES D'OUVERTURE

Du lundi au vendredi  
de 10h à 12h  
et de 14h à 19h

Samedi (sur RDV)  
Dimanche fermé



### NOUS TÉLÉPHONER

02 50 50 50 82



### NOUS ÉCRIRE

contact@solutiontechniqueevenement.com



### NOTRE ADRESSE

27 ter, rue du Marais  
14000 CAEN



INSTAGRAM

Solution Technique Evenement STE



FACEBOOK

Solution Technique Evenement STE



LINKEDIN

Solution Technique Evenement STE

### SUIVEZ NOUS !



NOTRE SITE INTERNET

[www.solutiontechniqueevenement.fr](http://www.solutiontechniqueevenement.fr)

02.50.50.50.82

*Ste*



contact@solutiontechniqueevenement.com

**2**



# NOTRE SITE INTERNET



Retrouvez tous nos produits en location ainsi que nos actualités sur notre site internet

[WWW.SOLUTIONTECHIQUEEVENEMENT.FR](http://WWW.SOLUTIONTECHIQUEEVENEMENT.FR)



# NOUS TROUVER !

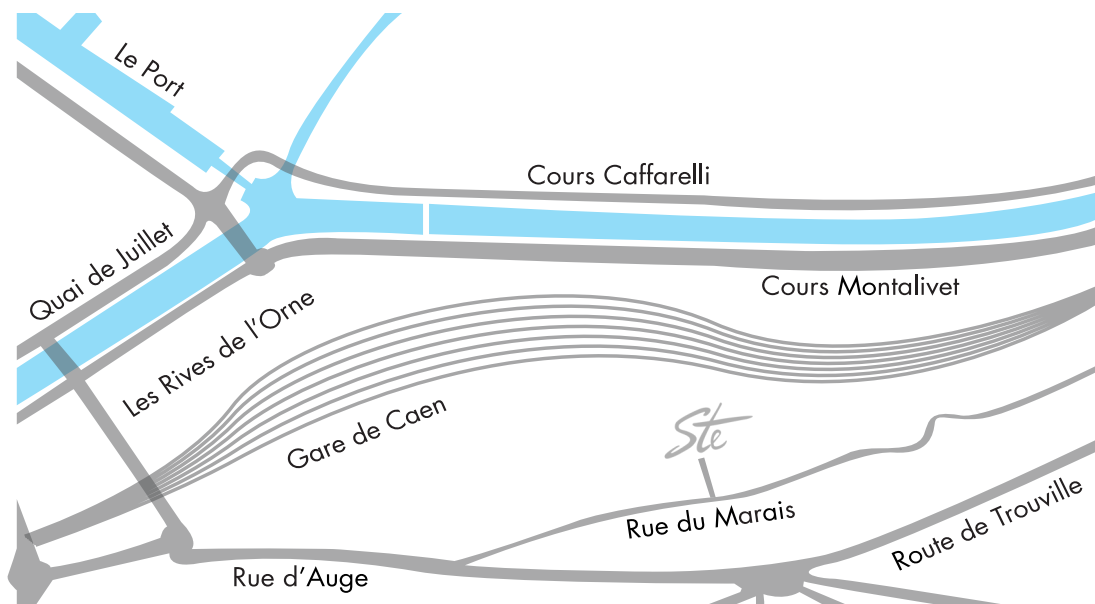

27 ter, rue du Marais  
14000 CAEN

3

02.50.50.50.82

Ste

contact@solutiontechniqueevenement.com





# COEFFICIENTS ET CONDITIONS

NOMBRE DE JOURS	COEFFICIENTS MULTIPLICATEURS
1	1.00
2	1.50
3	2.00
4	2.20
5	2.40
6	2.60
7	2.80
8	3.00
9	3.20
10	3.40
11	3.60
12	3.80
13	4.00
Autre	Sur devis



ATTENTION, POUR TOUTES COMMANDES PASSÉES DANS UN DÉLAI INFÉRIEUR À 7 JOURS AVANT L'ÉVÉNEMENT, NOUS NOUS RÉSERVONS LE DROIT DE FACTURER DES FRAIS SUPPLÉMENTAIRES.

Notre grille, ci-contre, vous permet de calculer le coût de location du matériel selon la durée totale d'immobilisation estimée :

$$\text{TARIF HT / JOUR} \\ \times \\ \text{COEFFICIENT MULTIPLICATEUR}$$

Les coefficients sont dégressifs pour vous proposer le matériel dans les meilleures conditions tarifaires.

Pour les locations de plus de 13 jours, un devis sur mesure vous sera proposé.

Ces coefficients couvrent l'intégralité de la période d'absence du matériel, quelle qu'en soit l'utilisation.



NOUS METTONS À VOTRE DISPOSITION UN **ÉQUIPEMENT DERNIER CRI** ET **SOIGNEUSEMENT ENTRETENU**, VOUS PERMETTANT UNE **EXPLOITATION OPTIMALE** DU MATÉRIEL LOUÉ.



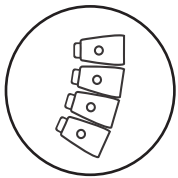

# SONORISATION

## ENCEINTES SUR BATTERIE

**MIPRO**

**audiophony**  
EQUIPMENTS



**Bluetooth®**

ENCEINTE SUR BATTERIE  
**AUDIOPHONY CR12A 120 W**  
MP3 - USB - SD  
DOUBLE MICRO HF

55 € H.T. / jour Stock : 2



**Bluetooth®**

ENCEINTE SUR BATTERIE  
**AUDIOPHONY CROSSER 180W**  
CD - MP3 - USB - SD  
DOUBLE MICRO HF

59 € H.T. / jour Stock : 1

ENCEINTE SUR BATTERIE  
**AUDIOPHONY CR25A 250W**  
MP3 - USB - SD  
DOUBLE MICRO HF

70 € H.T. / jour Stock : 2



**Bluetooth®**



**Bluetooth®**

ENCEINTE SUR BATTERIE  
BANDOULIÈRE  
**MIPRO MA 100DB**

35 € H.T. / jour Stock : 1

Micro serre tête en option compatible avec les enceintes sur batterie.

10 € H.T. / Jour



Stock : 1

## ENCEINTES « COLONNES » ACTIVES

**LDsystems** LD  
Free your sound



**LD SYSTEMS MAUI 05 GO**  
SUR BATTERIE

50 € H.T. / jour

Stock : 6



**LD SYSTEMS MAUI 11 G2**

60 € H.T. / jour

Stock : 8



**LD SYSTEMS MAUI 28 G2**

90 € H.T. / jour

Stock : 8



**LD SYSTEMS MAUI 44 G2**

120 € H.T. / jour

Stock : 4

# 5

02.50.50.50.82

*Ste*

contact@solutiontechniqueevenement.com



## CAISSONS DE BASSE ACTIFS

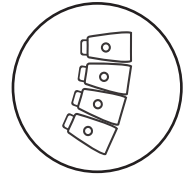

**YAMAHA DXS15**

40 € H.T. / jour

Stock : 3



**JBL PRX618S**

35 € H.T. / jour

Stock : 2



**JBL SRX828 SP**

80 € H.T. / jour

Stock : 2

## ENCEINTES ACTIVES



**DXR10**

35 € H.T. / jour

Stock : 4



**DXR12**

40 € H.T. / jour

Stock : 12



**DXR15**

45 € H.T. / jour

Stock : 8



**DZR12**

65 € H.T. / jour

Stock : 8

## SUPPORTS D'ENCEINTES



**PAIRE DE PIED ENCEINTE  
K&M**

8 € H.T. / jour

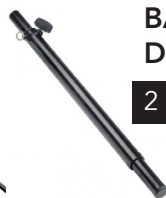

**BARRE  
DE COUPLAGE**

2 € H.T. / jour

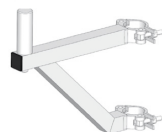

**SUPPORT TOTEM**

4 € H.T. / jour

## LIGNE 100 V



**JBL CONTROL 25**

18 € H.T. / jour

Stock: 18



**AUDIOPOLE ZONE 4-120**

40 € H.T. / jour

Stock: 1

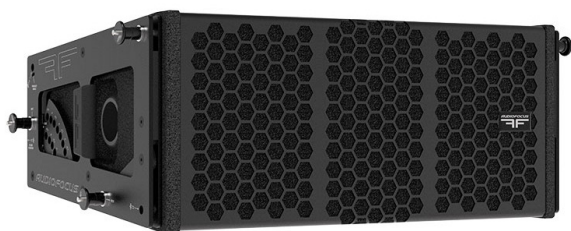
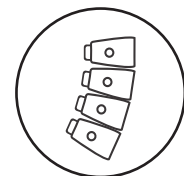

ENCEINTE LINE ARRAY  
ACTIVE ARES 8A

65 € H.T. / jour

Stock : 16



CAISSON DE BASSE  
ACTIF S21A

75 € H.T. / jour

Stock : 8



CAISSON DE BASSE  
ACTIF B18A «FLY»

65 € H.T. / jour

Stock : 4

NOUVEAUTÉ 2023 !

BUMPER GRAPPE

30 € H.T. / jour

Stock : 2



BUMPER STACK

15 € H.T. / jour

Stock : 4



Possibilité de fixer les Bumpers grappes sur les pieds FANTEK FT 6033 à la page

45



02.50.50.50.82



contact@solutiontechniqueevenement.com



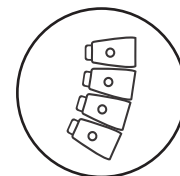

**SYVA + LOW  
SYSTEME SOURCE COLINEAIRE**

210 € H.T. / jour

Stock : 2



**SB18M**

45 € H.T. / jour

Stock : 2

**AMPLI LA4X**

75 € H.T. / jour

Stock : 2



# MIXAGE NUMÉRIQUE ET ANALOGIQUE



ALLEN&HEATH

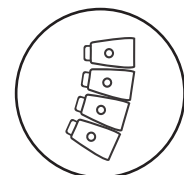

MG06 YAMAHA

15 € H.T. / jour

Stock : 10



MG12 YAMAHA XU

25 € H.T. / jour

Stock : 2



MG16 YAMAHA XU

35 € H.T. / jour

Stock : 1



SQ-5 ALLEN&HEATH

95 € H.T. / jour

Stock : 1

NOUVEAUTÉ 2023 !



QU-24 ALLEN&HEATH

105€ H.T. / jour

Stock : 1



QU-SB ALLEN&HEATH

45 € H.T. / jour

Stock : 1



DX-168 ALLEN&HEATH

50 € H.T. / jour

Stock : 1



NOUVEAUTÉ 2023 !

AR-2412 ALLEN&HEATH

80 € H.T. / jour

Stock : 1



ROULE RJ45  
ETHERCON CAT7

**50M** 20 € H.T. / jour

Stock : 1

**100M** 35 € H.T. / jour

Stock : 1

ROULE XLR

**50M** 5 € H.T. / jour

**100M** 10 € H.T. / jour

## PIEDS DE MICRO



PETIT PIED DE MICRO

3 € H.T. / jour



PIED DE MICRO

6 € H.T. / jour

# 9

02.50.50.50.82

[contact@solutiontechniqueevenement.com](mailto:contact@solutiontechniqueevenement.com)



LIAISON HF

MIPRO

audio-technica

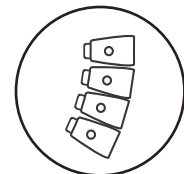

### LIAISON HF MIPRO ACT 72B

Simple 30 € H.T. / jour Double 50 € H.T. / jour Triple 70 € H.T. / jour

Quadruple 90 € H.T. / jour

Stock : 12



### ANTENNE AT 90W

20 € H.T. / jour

Stock : 2



### AUDIOTECHNICA ATW3212

25€ H.T. / jour

Stock : 6



Micro main C510

15 € H.T. / jour

Stock : 6



Micro casque BP894XCH-TH + POCKET ATW-T3201

25 € H.T. / jour

Stock : 3

## SOLUTION TRANSMISSION HF



ÉMETTEUR MIPRO MT 92A



BOOSTER AD-90A

### KIT HF - 1\*ÉMETTEUR + 1\*BOOSTER

40 € H.T. / jour

Stock : 2



RÉCEPTEUR MR 90B

20 € H.T. / jour

Stock : 4



### KIT HF EAR MONITOR MIPRO - ÉMETTEUR MI58T + RÉCEPTEUR MI58R

35 € H.T. / jour

NOUVEAUTÉ 2023 !

Stock : 1

## SOLUTION AUDIO GUIDE



### ÉMETTEUR

POCKET +SERRE TÊTE

30€ H.T. / jour

Stock : 3 ↑

MICRO MAIN ACT-80HC

20€ H.T. / jour

Stock : 6 ↑



### RÉCEPTEUR MIPRO MTG 100R

12 € H.T. / jour

Stock : 60 ↑



### CASQUE AUDIO

2 € H.T. / jour

Stock : 60



### SOLUTION COMPLÈTE AUDIO GUIDE

48\*RÉCEPTEURS & CASQUES + 1\*ÉMETTEUR

549 € H.T. / jour

Stock : 1

## MICROPHONES FILAIRES

**SHURE**  **SENNHEISER** 

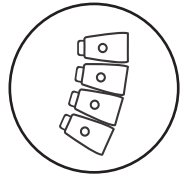

**SM58**

10 € H.T. / jour

Stock : 10



**PG57**

10 € H.T. / jour

Stock : 2



**SM57**

10 € H.T. / jour

Stock : 4



**SENNHEISER E835S**

10 € H.T. / jour

Stock : 10



**SM7B**

20 € H.T. / jour

Stock : 2



**SENNHEISER E604**

10 € H.T. / jour

Stock : 4



**SENNHEISER E604**

10 € H.T. / jour

Stock : 1



**SENNHEISER E905**

10 € H.T. / jour

Stock : 1



**AUDIOTECHNICA AT2031**

10 € H.T. / jour

Stock : 4



**MICRO COL DE CIGNE COURT  
ES915H AUDIO TECHNICA**

15 € H.T. / jour

Stock : 2



**MICRO COL DE CIGNE LONG  
ELECTROVOICE POLARCHOICE  
18**

20 € H.T. / jour

Stock : 2

## ACCESSOIRES AUDIO

**AMiX** Focusrite



**DJ SOUND WARMER  
FREEVOX**

35 € H.T. / jour

Stock : 1



**PROCESSEUR NUMÉRIQUE**

**DBX DRIVERACK PA2** 30 € H.T. / jour

Stock : 1

**T.RACKS DSP 408** 35 € H.T. / jour

Stock : 1



**CARTE SON  
FOCUSRITE 1818**

15 € H.T. / jour

Stock : 1



**BSS AR133**

8 € H.T. / jour

Stock : 4

**NOUVEAUTÉ 2023!**



CONFORME À LA NORME NF S31-122-1-2017

CONFORME AU DÉCRET DU 07 AOÛT 2017



**AFFICHEUR ENREGISTREUR  
DE PRESSION ACOUSTIQUE  
AMiX AFF25-3 + CAPTEUR DE  
PRESSION ACOUSTIQUE  
CAP65A**

80 € H.T. / jour

Stock : 1



**MICRO DE MESURE  
DBX RTA-M**

8 € H.T. / jour

Stock : 2

**11**

 02.50.50.50.82

*Ste*

 contact@solutiontechniqueevenement.com

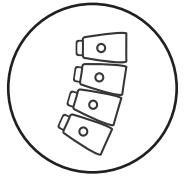

**NOUVEAUTÉ 2023!**

**DJM-A9**

**110 € H.T. / jour**

Stock : 1



**ALLEN&HEATH  
XONE 92**

**60 € H.T. / jour**

Stock : 1



**ALLEN&HEATH  
XONE 96**

**85 € H.T. / jour**

Stock : 1

**NOUVEAUTÉ 2023!**

rekordbox serato DJ Pro



**DJM-900  
NEXUS 2**

**90 € H.T. / jour**

Stock : 3

serato DJ Pro



**DJM-S9**

**70 € H.T. / jour**

Stock : 1

serato DJ Pro



**DJM-S11**

**90 € H.T. / jour**

Stock : 1

**NOUVEAUTÉ 2023!**

rekordbox serato DJ Pro



**CDJ-3000**

**100 € H.T. / jour**

Stock : 4

rekordbox serato DJ Pro



**CDJ-2000 NEXUS 2**

**85 € H.T. / jour**

Stock : 3

**FOURNIE SANS CELLULE ET DIAMANT**



**TECHNICS SL1200 MK2**

**50 € H.T. / jour**

Stock : 2

serato DJ Pro



**RANE TWELVE**

**60 € H.T. / jour**

Stock : 2

**NOUVEAUTÉ 2023!**



rekordbox

**XDJ-RX2**

**90 € H.T. / jour**

Stock : 1



rekordbox serato DJ Pro

**XDJ-RX3**

**115 € H.T. / jour**

Stock : 1



rekordbox serato DJ Pro

**XDJ-XZ**

**149 € H.T. / jour**

Stock : 1



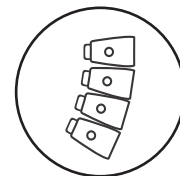

## DEVANTURE DJ



DEVANTURE DJ SUPPORT PC  
ALUMINIUM OU BLACK

20 € H.T. / jour

**BLACK** Stock : 1

**ALU** Stock : 4



LYCRA BLANC OU NOIR POUR  
DEVANTURE DJ

10 € H.T. / jour

INFORMATIQUE



Lenovo ThinkPad



IPAD AIR 4

30€ H.T. / jour

Stock : 2



PC WINDOWS LENOVO THINKPAD

49€ H.T. / jour

Stock : 4



02.50.50.50.82



[contact@solutiontechniqueevenement.com](mailto:contact@solutiontechniqueevenement.com)



# LUMIÈRES

## LOGICIELS DE CONTRÔLE

sunlite

AKAI  
PROFESSIONAL

MADRIX  
LIGHTING CONTROL



LOGICIEL DE CONTRÔLE  
ILDA PANGOLIN

30 € H.T. / jour

Stock : 1



INTERFACE SUNLITE  
SUITE 2 & SUITE 3

25 € H.T. / jour

Stock : 6



APC40 MK2

15 € H.T. / jour

Stock : 2



MADRIX 5 PRO  
128 UNIVERS

50 € H.T. / jour

Stock : 1

## CONSOLES LUMIÈRE

MA  
LIGHTING

ADJ



MA LIGHTING DOT 2 XL-B

140 € H.T. / jour

Stock : 1



IPAD NON INCLU

NOUVEAUTÉ 2023 !

ADJ LINK

50 € H.T. / jour

Stock : 1



NOUVEAUTÉ 2023 !

WOLFMIX W1

60 € H.T. / jour

Stock : 4

## AUTRES



BLOC DE PUISSANCE  
OMNICANAL

8 € H.T. / jour

Stock : 4

NOUVEAUTÉ 2023 !



BLOC DE PUISSANCE  
4 CANAUX

15 € H.T. / jour

Stock : 1



SYSTÈME DE  
CONTROLE DMX HF

10 € H.T. / jour

Stock : 12



SPLITTER DMX 3 ENTRÉES  
(3 OU 5 POINTS) 8 SORTIES  
(3 POINTS)

10 € H.T. / jour

Stock : 6



SYSTÈME DE LIAISON DMX HF  
ELECTROCONCEPT

NOUVEAUTÉ 2023 !

EMETEUR HF

10 € H.T. / jour

Stock : 6

RÉCEPTEUR HF

5 € H.T. / jour

Stock : 20

02.50.50.82

Ste

contact@solutiontechniqueevenement.com

14



# GAMME IP EXTÉRIEURE/INTÉRIEURE



## PROJECTEURS ASSERVIS IP



**BEAM 1R IP65 HYDRO BEAM  
X1 OSRAM 100W HRI**

60 € H.T. / jour

Stock : 4

**NOUVEAUTÉ 2023 !**



**BEAM IP65 HYDRO BEAM X2  
OSRAM 370W HRI**

80 € H.T. / jour

Stock : 2



**NOUVEAUTÉ 2023 !**

**BARRE LED MOTORISÉE ZOOM/  
TILT CHAUVET COLORADO PXL  
BAR 16X45W RGBW**

130 € H.T. / jour

Stock : 20

## DÉCOUPES LED IP



**DÉCOUPE LED 230W  
IP CHAUVET OVATION  
E260WW**



BLANC CHAUD

70 € H.T. / jour

Stock : 2



Possibilité de création de Gobo sur mesure:

Nous consulter

Optiques à la demande.



02.50.50.50.82



contact@solutiontechniqueevenement.com



## PROJECTEURS LED IP



PAR LED IP 54X5W  
RGB

29 € H.T. / jour

Stock : 12



PALADIN ELATION IP  
ZOOM 24X40W RGBW

80 € H.T. / jour

Stock : 1



PAR LED BATTERIE IP  
/ DMX WIFI 4X10W  
RGBWAUV

20 € H.T. / jour

Stock : 108



PAR LED IP 7X12W  
RGBWAUV

20 € H.T. / jour

Stock : 36

**NOUVEAUTÉ 2023 !**



BLINDER LED  
4X100W IP



BLANC FROID BLANC CHAUD

30 € H.T. / jour

Stock : 4

**NOUVEAUTÉ 2023 !**

## GAMME INTÉRIEURE (NON IP)

### PROJECTEURS ASSERVIS



BEAM 1R RXONE OSRAM  
100W HRI

35 € H.T. / jour

Stock : 20



LED PANEL MATRIÇABLE  
25X12W RGBW

50 € H.T. / jour

Stock : 8



LYRE WASH STARWAY  
MODENA 7X40 RGBW

65 € H.T. / jour

Stock : 12

**NOUVEAUTÉ 2023 !**



LYRE SPOT STARWAY LUSSO  
320W LED

120 € H.T. / jour

Stock : 8



DÉCOUPE LED 120W



BLANC CHAUD

35 € H.T. / jour

Stock : 4



DÉCOUPE LED 32W



BLANC FROID BLANC CHAUD

20 € H.T. / jour

Stock : 4

LASERS

SYSTÈME DE SÉCURITÉ INCLU DANS TOUS LES LASERS.



LASER 1.5W

39 € H.T. / jour

Stock : 4



LASER 3W

89 € H.T. / jour

Stock : 2

PROJECTEURS LED



NOUVEAUTÉ 2023 !

STROBOSCOPE JOLT  
PANEL FX

35 € H.T. / jour

Stock : 8



PAR LED 5X4W RGBUV

8 € H.T. / jour

Stock : 60



PAR 12X12W  
RGBWAUV

14 € H.T. / jour

Stock : 8



PROJECTEUR UV  
LED 24X3W

19 € H.T. / jour

Stock : 8



PAR COB LED 100W



BLANC FROID BLANC CHAUD

27 € H.T. / jour

Stock : 20







**SKYBAR V3**

15 € H.T. / jour

Stock : 40

**PIED POUR SKYBAR V3**

Inclu sur demande dans la location

Stock : 20

**MOTEUR POUR BOULE À FACETTE DMX - 40  
KG MAX CONTROLE DU SENS ET DE LA VITESSE  
DE ROTATION DE 0,5 À 5 TOURS MINUTE**

20 € H.T. / jour

Stock : 1



**NOUVEAUTÉ 2023 !**



**NOUVEAUTÉ 2023 !**

**BOULE À FACETTES DIAMÈTRE 1M**

100 € H.T. / jour

Stock : 1







STARWAY ORION

65 € H.T. / jour

Stock : 2



PIED EN BOIS

10 € H.T. / jour

Stock : 4

ADMIRAL VINTAGE

**DIAMÈTRE 38CM** 35 € H.T. / jour Stock : 2

**DIAMÈTRE 53CM** 45 € H.T. / jour Stock : 2





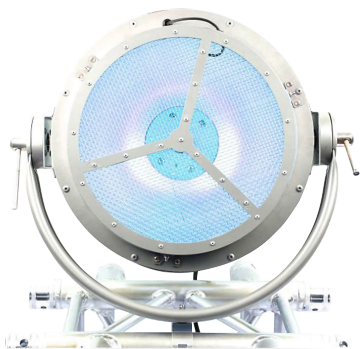
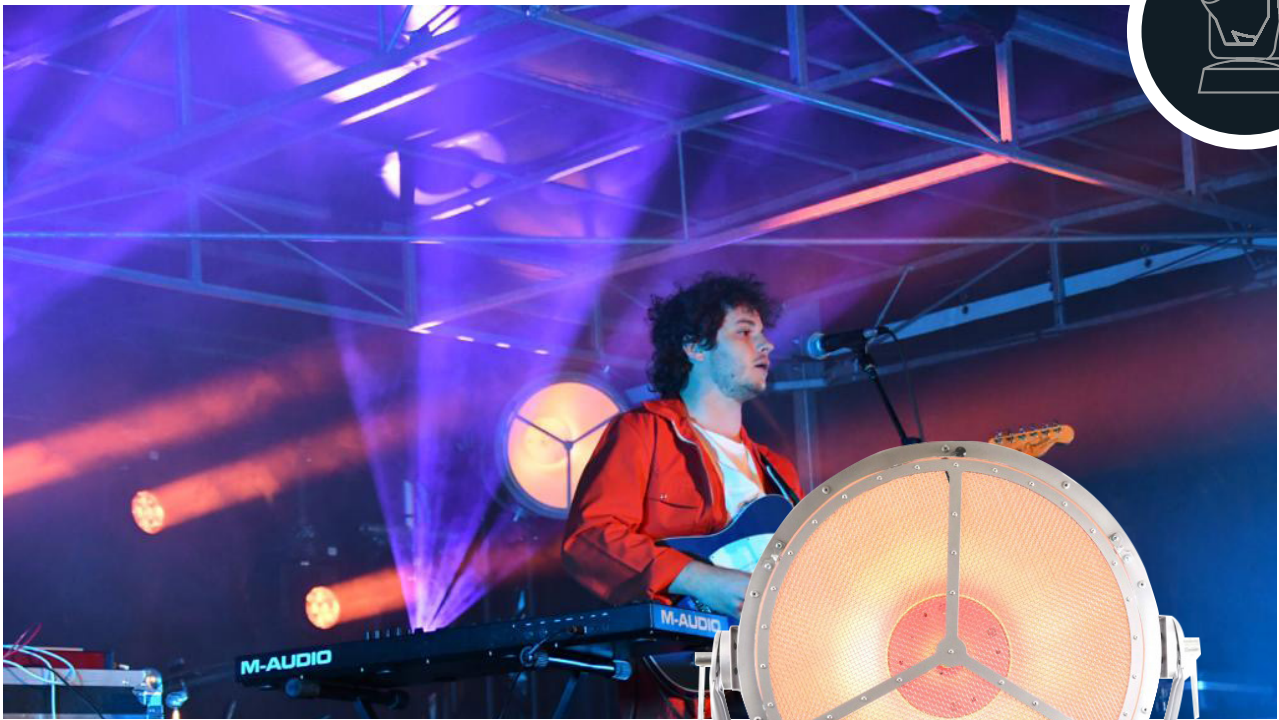

**PAT 500 RGB**

35 € H.T. / jour

Stock : 2



**PAT 750 RGB**

45 € H.T. / jour

Stock : 2

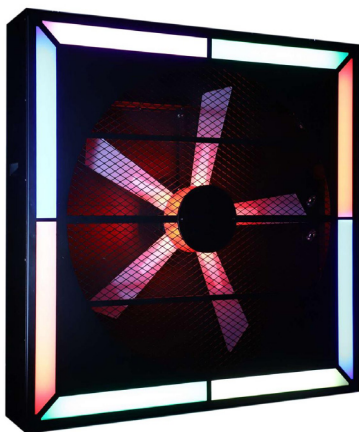

**VENTILATEUR LED XXL  
1X1M**

55 € H.T. / jour

Stock : 2





# KINETIC BALL



NOUVEAUTÉ 2023 !



MOTEUR LIFTING-BALL

85 € H.T. / jour

Stock : 40



LIFTING-BALL RGBW  
35CM

25 € H.T. / jour

Stock : 40



LIFTING-BALL RGBW  
25CM

15 € H.T. / jour

Stock : 40



☎ 02.50.50.50.82



✉ [contact@solutiontechniqueevenement.com](mailto:contact@solutiontechniqueevenement.com)



# GUIRLANDE GINGUETTE



CHAPITEAU GINGUETTE



GINGUETTE EXTERIEUR





GUINGUETTE «LUSTRE»



POTEAU BAMBOU EXTERIEUR



POTEAU BAMBOU INTERIEUR



GUINGUETTE INTERIEUR «ZIG ZAG»



GUIRLANDE GUINGUETTE LED AMBRE FIL NOIR

1,6 € H.T./ ml / jour

Stock : 3600 mètres



GUIRLANDE GUINGUETTE LED AMBRE FIL BLANC

1,6 € H.T./ ml / jour

Stock : 400 mètres



**NOUVEAUTÉ 2023!**

POTEAU BAMBOU 3 MÈTRES AVEC JARDINIÈRE EN BOIS ET LESTAGE

60 € H.T. / jour

Stock : 24



02.50.50.50.82



[contact@solutiontechniqueevenement.com](mailto:contact@solutiontechniqueevenement.com)



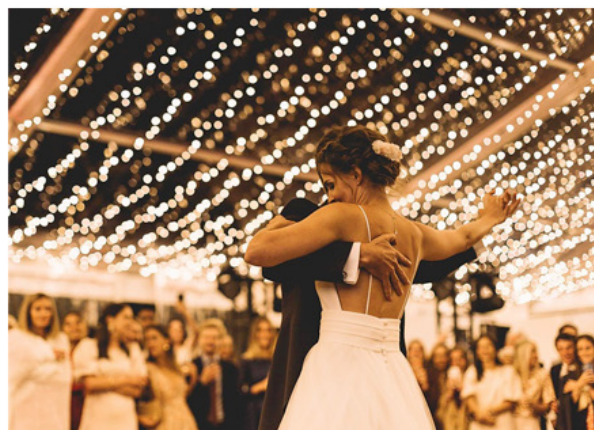
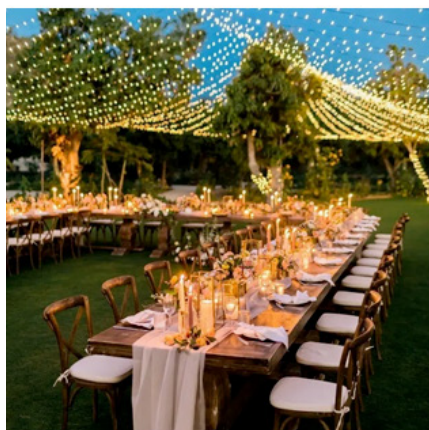

BLANC CHAUD

## GUIRLANDE LUMINEUSE LED BLANC CHAUD FIL BLANC

1 € H.T./ ml / jour

Stock : 5000 mètres



BLANC FROID

## GUIRLANDE LUMINEUSE LED BLANC FROID FIL BLANC

1 € H.T./ ml / jour

Stock : 1200 mètres



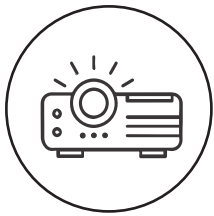

# VIDÉO

## VIDÉO-PROJECTEURS

**Panasonic Benq**



PANASONIC 3100 LUMENS HD

40 € H.T. / jour

Stock : 4



BENQ 3400 LUMENS HD  
COURTE FOCALE

45 € H.T. / jour

Stock : 8



PANASONIC 6000 LUMENS LASER  
FULL HD

270 € H.T. / jour

Stock : 2

## ÉCRANS DE PROJECTION



**\*TAILLE D'IMAGE**

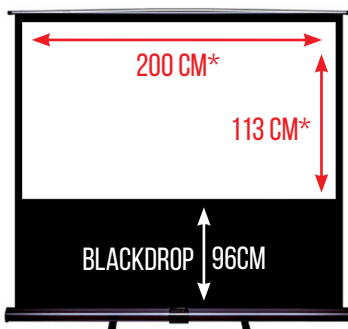

ÉCRAN DE PROJECTION  
FRONTALE PORTABLE

20 € H.T. / jour

Stock : 8

**\*TAILLE D'IMAGE**

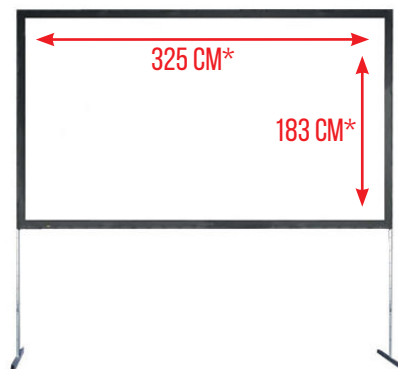

ÉCRAN VALISE DE PROJECTION FRONTALE  
ET RÉTRO-PROJECTION

65 € H.T. / jour

Stock : 2

**\*TAILLE D'IMAGE**

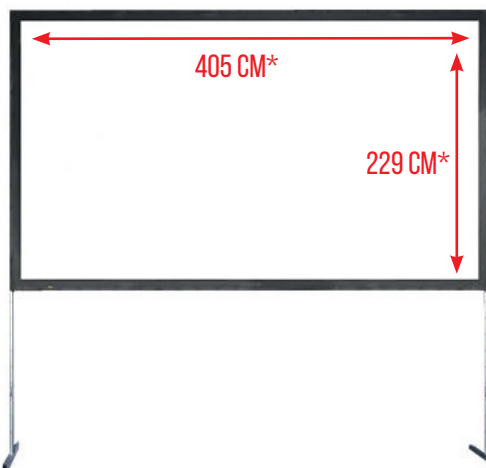

ÉCRAN VALISE DE PROJECTION FRONTALE  
ET RÉTRO-PROJECTION

85 € H.T. / jour

Stock : 2



02.50.50.50.82



[contact@solutiontechniqueevenement.com](mailto:contact@solutiontechniqueevenement.com)

ÉCRANS

Panasonic

SAMSUNG

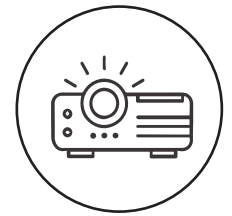

NOUVEAUTÉ 2023!



ECRAN 85'  
SAMSUNG

480 € H.T. / jour

Stock : 2

ECRAN 70'  
SAMSUNG

280 € H.T. / jour

Stock : 2

ECRAN 55'  
PANASONIC

140 € H.T. / jour

Stock : 6

ECRAN 40'  
SAMSUNG

80 € H.T. / jour

Stock : 6

## ÉCRAN LED PLEIN JOUR



DALLE ÉCRAN LED PLEIN  
JOUR INDOOR / OUTDOOR  
PITCH 4,8MM 50 X 50 CM

60 € H.T. / jour

Stock : 64



NOVASTAR VX4S

180€ H.T. / jour

Stock : 2



BUMPER

15 € H.T. / jour

Stock : 15

02.50.50.50.82

Ste

contact@solutiontechniqueevenement.com

26

# CAPTATION VIDÉO ET ACCESSOIRES

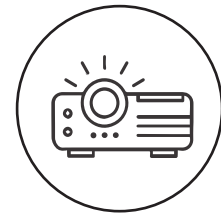

**CAMÉRA TOURELLE  
FULL HD PANASONIC  
AW-HE38**

100 € H.T. / jour

Stock : 2

**NOUVEAUTÉ 2023 !**



**PANASONIC  
AG-UX90**

80€ H.T. / jour

Stock : 1



**PUPITRE DE CONTRÔLE  
PANASONIC AW-RP60GJ**

100 € H.T. / jour

Stock : 1



**REGIE VIDÉO  
ATEM MINI PRO  
ISO**

49 € H.T. / jour

Stock : 1



**MINI PONT  
HF HDMI**

20 € H.T. / jour

Stock : 4



**NOUVEAUTÉ 2023 !**

**SUPPORT D'ÉCRAN RETOUR  
32 À 40 POUCES**

20 € H.T. / jour

Stock : 2



**NOUVEAUTÉ 2023 !**

**PIED DE CAMÉRA**

35 € H.T. / jour

Stock : 1



**POINTEUR LASER**

8 € H.T. / jour

Stock : 3



**FOND VERT DIMENSIONS  
3X6M FOURNI AVEC PIEDS  
ET STRUCTURE**

45 € H.T. / jour

Stock : 1



02.50.50.50.82



contact@solutiontechniqueevenement.com



# PHOTOBOOTHS



## BORNE SELFIE À IMPRESSION INSTANTANÉE

Nos bornes à selfie vous offrent des photos de grande qualité, idéales pour immortaliser votre évènement. Laissez les différentes générations se prendre au jeu d'une pose unique et figez le souvenir par une impression instantanée!

336 € H.T. / jour

Stock : 4 ↑



## BOBINE DE PAPIER SUPPLÉMENTAIRE

100 € H.T.

## CRÉATION D'UN TEMPLATE PERSONNALISÉ

Chez Solution Technique Évènement, bénéficiez d'un graphiste dédié à la création d'un template à votre image.

50 € H.T.

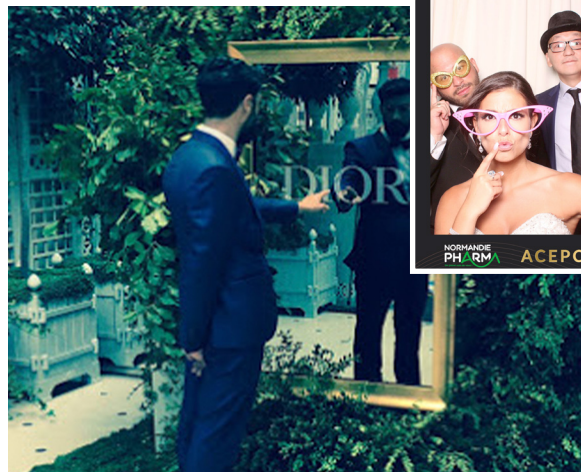

## MIROIR PHOTO À IMPRESSION INSTANTANÉE

Une nouveauté alliant élégance et originalité, le miroir magique est une nouvelle génération de borne selfie qui sublimerait votre évènement et les souvenirs qui lui sont associés.

499€ H.T. / jour

Stock : 1

## LES PRESTATIONS INCLUSES DANS VOTRE LOCATION



400 tirages papier inclus en impression instantanée !



Toutes les photos à disposition sur une galerie web en accès privé à l'issue de l'évènement.



Création et envoi d'un mail personnalisé avec la photo prise par vos convives.



Programmation interne du photobooth selon vos souhaits (couleur, nombre d'impression...)



# EFFETS SPÉCIAUX

## MACHINE À MOUSSE

Prix affichés consommables inclus.



**NOUVEAUTÉ 2023!**

**MACHINE À MOUSSE SFAT POWER FOAM 500  
- CASCADE OU JETS**

Tarif: 400 € H.T. / jour

Stock : 1

**MACHINE À MOUSSE SFATENERGY  
FOAM TWO**

Tarif: 150 € H.T. / jour

Stock : 2

## MACHINE À NEIGE

Prix affichés consommables inclus.



**MACHINE À NEIGE  
PORTATIVE EN JET**

150 € H.T. / jour

Stock : 1



**MACHINE À NEIGE SFAT  
POWER SNOW 500**

280 € H.T. / jour

Stock : 1



☎ 02.50.50.50.82



✉ [contact@solutiontechniqueevenement.com](mailto:contact@solutiontechniqueevenement.com)



# MACHINE À BULLES

Prix affichés consommables inclus.



## MACHINE À BULLES DOUBLE SORTIE

29 € H.T. / jour

Stock : 4



## MACHINE À BULLES DE FUMÉE

39 € H.T. / jour

Stock : 2

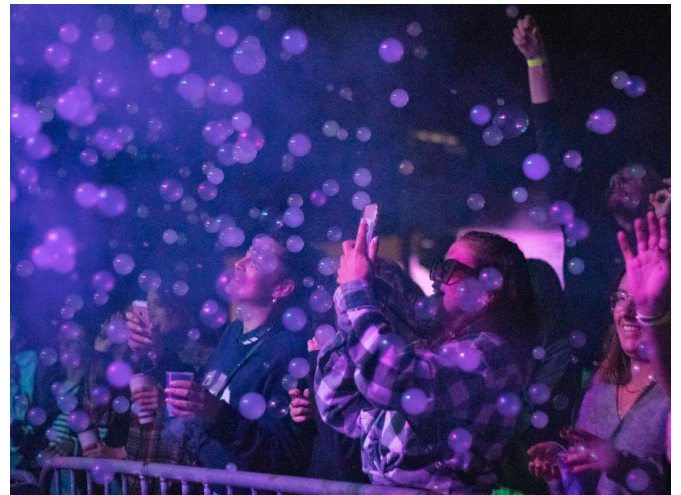

## MUR DE BULLES

210 € H.T. / jour

Stock : 1



# MACHINE À CONFETTIS

Prix affichés hors consommables.

**MAGICFX**



## POWER SHOT MAGIC FX

28 € H.T. / jour

Stock : 12

## CANON À CONFETTIS GUN MAGIC FX

55 € H.T. / jour

Stock : 1



## CANON À CONFETTIS XL SFAT ENERGY STREAMER

120 € H.T. / jour

Stock : 2



## MAGIC FX CLUBBLOWER

90 € H.T. / jour

Stock : 2

**NOUVEAUTÉ 2023!**



## SOUFFLERIE CONFETTIS SFAT POWER CONFETTI 500

210 € H.T. / jour

Stock : 1

Les tarifs des consommables sont disponibles à la **page 50**.



**31**

☎ 02.50.50.50.82

*Ste*

✉ contact@solutiontechniqueevenement.com



**ÉTINCELLES FROIDES  
SPARKULAR MINI**

60 € H.T. / jour

Stock : 12



**ÉTINCELLES FROIDES  
SPARKULAR MINI FALL**

75 € H.T. / jour

Stock : 2



**LANCE FLAMME MAGIC  
FX FLAMANIAC**

210 € H.T. / jour

Stock : 2



**NOUVEAUTÉ 2023!**

**LANCE FLAMME MAGIC  
FX FLAME BLAZER**

270 € H.T. / jour

Stock : 4

Les tarifs des consommables sont disponibles à la **page 50**.

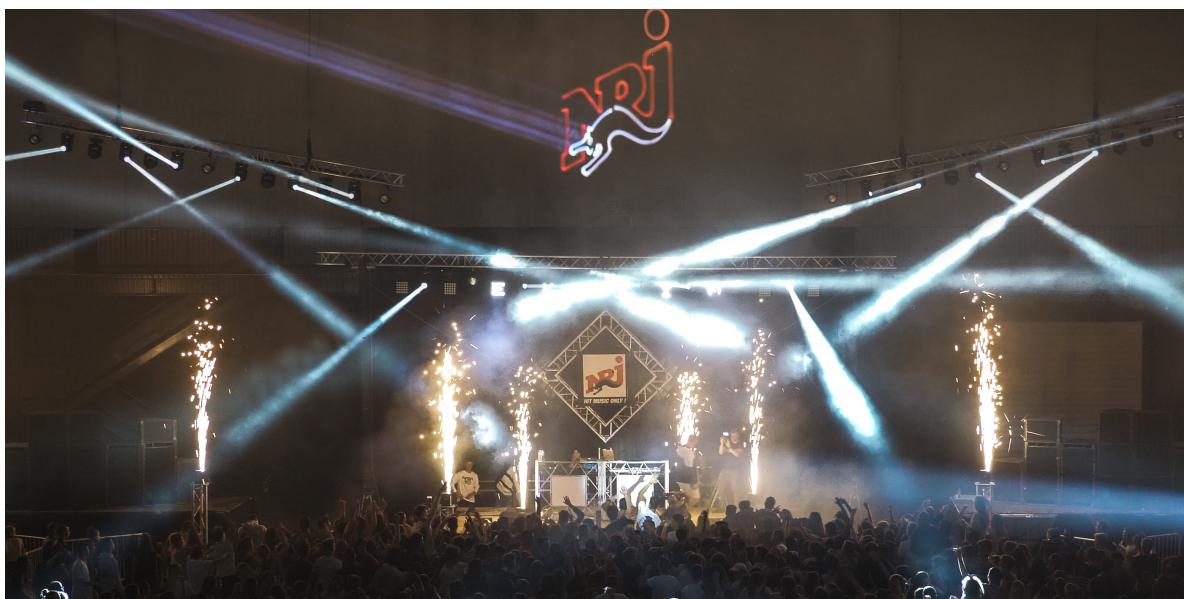

## CANONS À CO2

Prix affichés hors consommables.



MAGIC FX CO2 GUN II

49 € H.T. / jour

Stock : 2



**NOUVEAUTÉ 2023 !**

MAGIC FX CO2 JET II

59 € H.T. / jour

Stock : 4

Les tarifs des consommables sont disponibles à la **page 50**.

## MACHINE À BROUILLARD

Prix affichés consommables inclus.



MACHINE À BROUILLARD  
1500W

29 € H.T. / jour

Stock : 5

## MACHINE À FUMÉE LOURDE

Prix affichés hors consommables.



MACHINE À FUMÉE LOURDE CHAUVET  
NIMBUS CARBOGLACE

80 € H.T. / jour

Stock : 3



MACHINE À FUMÉE LOURDE À EAU  
HEAVY FOG 3000

95 € H.T. / jour

Stock : 2

Les tarifs des consommables sont disponibles à la **page 50**.



02.50.50.50.82



contact@solutiontechniqueevenement.com



## GEYSERS DE FUMÉE

Prix affichés consommables inclus.



**GEYSERS PRO 1500W**

32,5 € H.T. / jour

Stock : 8

## LÂCHER DE RIDEAU

**MAG:CFX®**



**POWER DROP MAGIC FX  
KABUKI**

26 € H.T. / jour

Stock : 20

**Drop Effect**

☎ 02.50.50.50.82

*Ste*

✉ contact@solutiontechniqueevenement.com

**34**

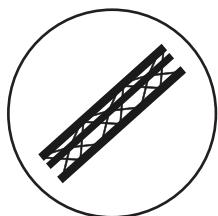

# SCÈNE ET STRUCTURE

## PRATICABLES DE SCÈNE

Pieds de praticables non inclus dans le tarif de location.



TOUTE NOTRE GAMME DE PRATICABLE EST INDOOR/OUTDOOR ET SUPPORTE 750 KG/M2.

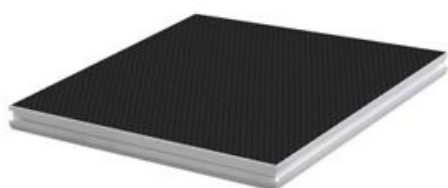

PRATICABLE DE SCÈNE

**1x1**

14 € H.T. / jour

Stock : 10

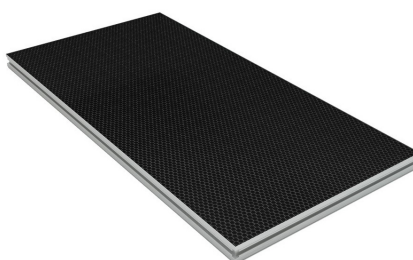

PRATICABLE DE SCÈNE

**2x1**

19 € H.T. / jour

Stock : 30 ↑

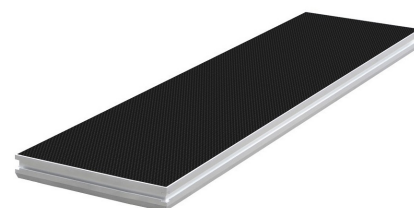

PRATICABLE DE SCÈNE

**2x0,5**

14 € H.T. / jour

Stock : 6 ↑



PRATICABLE DE SCÈNE **1M 90°**

32 € H.T. / jour

Stock : 8

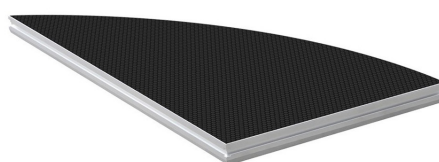

PRATICABLE DE SCÈNE  
ARRONDI DROITE/  
GAUCHE

38 € H.T. / jour

Stock : 4

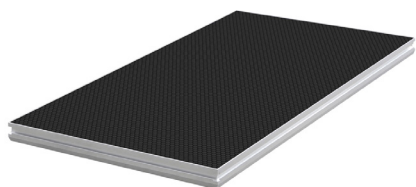

PRATICABLE DE SCÈNE **1x0,5**

10 € H.T. / jour

Stock : 2



**NOUVEAUTÉ 2023 !**

PRATICABLE DE SCÈNE  
TRIANGLE **1X1**

35 € H.T. / jour

Stock : 4



☎ 02.50.50.50.82



✉ [contact@solutiontechniqueevenement.com](mailto:contact@solutiontechniqueevenement.com)

# ACCESSOIRES SCÉNIQUES

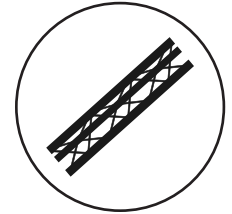

## PIED À ROULETTE HAUTEUR **30CM**



**PIED SIMPLE**

4 € H.T. / jour

Stock : 6



**PIED DOUBLE**

6 € H.T. / jour

Stock : 8

**NOUVEAUTÉ 2023!**



**PIED QUADRUPLE**

8 € H.T. / jour

Stock : 8

**NOUVEAUTÉ 2023!**

## PIED RÉGLABLE

Prix par pied

**20 CM** 0,50 € H.T. / jour

**40 À 60 CM** 1 € H.T. / jour

**60 À 100 CM** 1,5 € H.T. / jour

**NOUVEAUTÉ 2023!** **80 À 140 CM** 4 € H.T. / jour



## SYSTÈME DE FIXATION



**FIXATION PIED DOUBLE**

2 € H.T. / jour

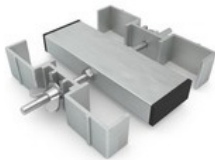

**FIXATION PIED QUADRUPLE**

4 € H.T. / jour

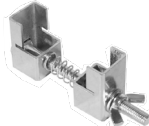

**SERRAGE LIAISON PRATICABLE**

1 € H.T. / jour



**MARCHES DE SCÈNE **20 À 80 CM****  
INDOOR & OUTDOOR

**80 CM** 40 € H.T. / jour Stock : 2  
**60 CM** 30 € H.T. / jour Stock : 2  
**40 CM** 20 € H.T. / jour Stock : 2  
**20 CM** 10 € H.T. / jour Stock : 2



**GARDE CORPS POUR PRATICABLE DE SCÈNE **1X1****

Stock : 2 **NOUVEAUTÉ 2023!**

10 € H.T. / ml / jour

**NOUVEAUTÉ 2023!**  
**GARDE CORPS POUR PRATICABLE DE SCÈNE **2X1****

Stock : 5

Modules de fixation inclus dans le tarif de location.





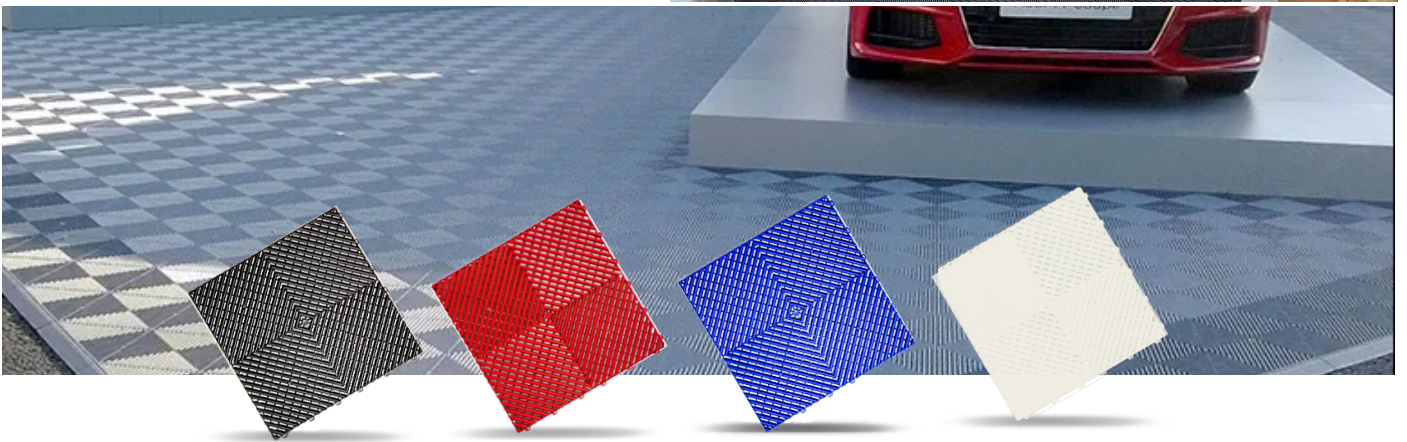

**REVÊTEMENT SOL/SCÈNE EXTÉRIEUR & INTERIEUR  
POLYDAL COULEUR AU CHOIX**

12 € H.T. / jour **LE M<sup>2</sup>**

**BAVETTES DE FINISSION ET ANGLES  
COMPRIS DANS LA LOCATION**

**JUPONNAGE**



DISPONIBLE EN



**JUPONNAGE DE SCÈNE**

Prix au mètre linéaire.

<b>20 CM</b>	1 € H.T. / ml / jour
<b>40 CM</b>	1,5 € H.T. / ml / jour
<b>60 CM</b>	2 € H.T. / ml / jour
<b>80 CM</b>	2,5 € H.T. / ml / jour
<b>100CM</b>	3 € H.T. / ml / jour

# GAZE ET PENDRILLONNAGE

LÉGENDE: **300G** (poids g/m2) **6** (Largeur en M) **X 3** (Hauteur en M)

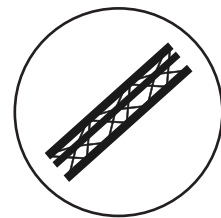

**NOUVEAUTÉ 2023 !**



**PENDRILLON NOIR**

**300G 3 X 3M**

15 € H.T. / jour

Stock : 10

**NOUVEAUTÉ 2023 !**



**PENDRILLON NOIR**

**300G 6 X 3M**

30 € H.T. / jour

Stock : 10

**NOUVEAUTÉ 2023 !**



**PENDRILLON NOIR**

**300G 9 X 3M**

45 € H.T. / jour

Stock : 4



**PENDRILLON NOIR**

**350G 3 X 4,5M**

24 € H.T. / jour

Stock : 22



**PENDRILLON BLANC**

**300G 3 X 5M**

30 € H.T. / jour

Stock : 10



**PENDRILLON BORDEAUX**

**300G 3X5M**

35 € H.T. / jour

Stock : 10



**PENDRILLON NOIR**

**300G 3 X 7M**

32 € H.T. / jour

Stock : 2



**GAZE DE SCÈNE**



TAUX DE PERMÉABILITÉ  
**37%**

**3 X 5CM**

20 € H.T. / jour

Stock : 6



TAUX DE PERMÉABILITÉ  
**16%**

**5 X 6CM**

30 € H.T. / jour

Stock : 2



SYSTEME DE FIXATION RAPIDE SUR TOUS NOS PENDRILLONS.



02.50.50.82

*Ste*



contact@solutiontechniqueevenement.com

**38**



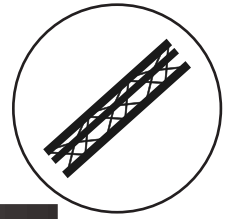

SC300 BLACK



STRUCTURE **0,145M** SC30145

**NOUVEAUTÉ 2023!**

6 € H.T. / jour

Stock : 4

STRUCTURE **0,25M** SC30025

**NOUVEAUTÉ 2023!**

6 € H.T. / jour

Stock : 4

STRUCTURE **0,29M** SC30029

7 € H.T. / jour

Stock : 10

STRUCTURE **0,5M** SC30050

8 € H.T. / jour

Stock : 10

STRUCTURE **1M** SC30100

10 € H.T. / jour

Stock : 20

STRUCTURE **1,5M** SC30150

**NOUVEAUTÉ 2023!**

15 € H.T. / jour

Stock : 4

STRUCTURE **2M** SC30200

20 € H.T. / jour

Stock : 20

STRUCTURE **3M** SC30300

**NOUVEAUTÉ 2023!**

25 € H.T. / jour

Stock : 10



**NOUVEAUTÉ 2023!**

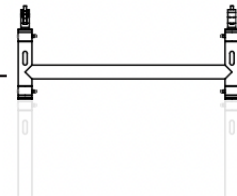

STRUCTURE ECHELLE HCAN

10 € H.T. / jour

Stock : 6

**NOUVEAUTÉ 2023!**

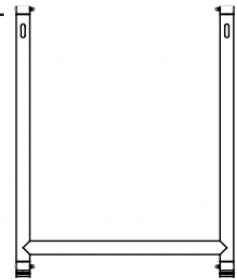

BARRE ECHELLE «H» HBN

10 € H.T. / jour

Stock : 12

**NOUVEAUTÉ 2023!**



STRUCTURE CERCLE  
DIAMÈTRE **2M** EN KIT  
DE 4 ARCS DE CERCLE

**ARC DE CERCLE**

20 € H.T. / jour

**CERCLE COMPLET**

80 € H.T. / jour

Stock: 1 cercle complet

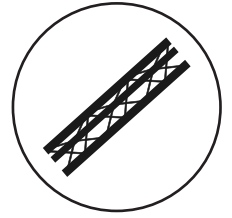

## SC300 ALUMINIUM



STRUCTURE **0,145M** SC30145

**NOUVEAUTÉ 2023!**

4 € H.T. / jour

Stock : 6 ↑



STRUCTURE **2M** SC30200

14 € H.T. / jour

Stock : 20 ↑

STRUCTURE **0,25M** SC30025

**NOUVEAUTÉ 2023!**

4 € H.T. / jour

Stock : 4

STRUCTURE **3M** SC30300

18 € H.T. / jour

Stock : 10 ↑

STRUCTURE **0,29M** SC30029

5 € H.T. / jour

Stock : 20 ↑

STRUCTURE **0,5M** SC30050

6 € H.T. / jour

Stock : 30

STRUCTURE **0,71M** SC30071

7 € H.T. / jour

Stock : 10

STRUCTURE **1M** SC30100

7 € H.T. / jour

Stock : 20 ↑

STRUCTURE **1,5M** SC30150

11 € H.T. / jour

Stock : 10 ↑

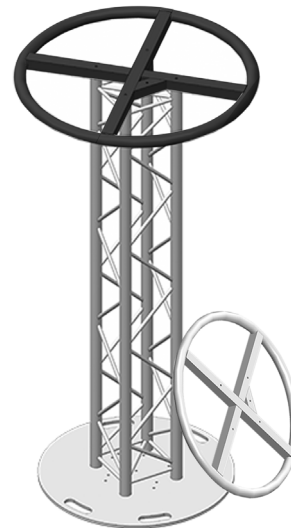

ANNEAU DIAMÈTRE **1M**  
ALU & BLACK

**BLACK** 30 € H.T. / jour Stock : 2

**ALU** 25 € H.T. / jour Stock : 2



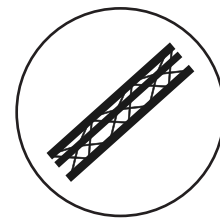

SC300 BLACK

ANGLE ASC3022

14 € H.T. / jour

Stock : 10 ↑



ANGLE ASC3031

20 € H.T. / jour

Stock : 12 ↑



ANGLE ASC3033

20 € H.T. / jour

Stock : 8 ↑



ANGLE ASC3042

26 € H.T. / jour

Stock : 4 ↑



ANGLE ASC3041

28 € H.T. / jour

Stock : 1

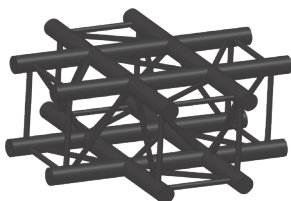

SC300 ALUMINIUM

ANGLE ASC3022

10 € H.T. / jour

Stock : 10 ↑



ANGLE ASC3031

14 € H.T. / jour

Stock : 12 ↑



ANGLE ASC3033

14 € H.T. / jour

Stock : 8 ↑



ANGLE ASC3042

18 € H.T. / jour

Stock : 12 ↑



ANGLE ASC3041

22 € H.T. / jour

Stock : 1



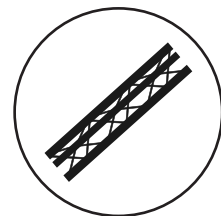

## STRUCTURES TRIANGULAIRES SX290



STRUCTURE **0,5M**  
SX29050

3 € H.T. / jour

Stock : 4

STRUCTURE **1M**  
SX29100

6 € H.T. / jour

Stock : 8

STRUCTURE **1,5M**  
SX29150

9 € H.T. / jour

Stock : 4

STRUCTURE **2M**  
SX29200

12 € H.T. / jour

Stock : 10

STRUCTURE **2,5M**  
SX29250

15 € H.T. / jour

Stock : 8

STRUCTURE **3M**  
SX29300

18 € H.T. / jour

Stock : 2

## STRUCTURES CARRÉES SZ290



STRUCTURE **2M**  
SX29200

12 € H.T. / jour

Stock : 10

STRUCTURE **1M**  
SX29100

6 € H.T. / jour

Stock : 4

## ANGLE TRIANGULAIRE SX290



ANGLE ASX32

12 € H.T. / jour

Stock : 8



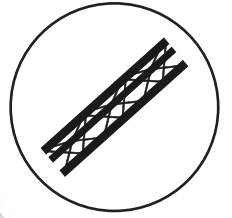

EMBASE LOURDE EML60  
DIAMÈTRE 60CM **33KG**

15 € H.T. / jour

Stock : 22



EMBASE LOURDE NOIRE  
DIAMÈTRE 60CM **38KG**

20 € H.T. / jour

Stock : 8

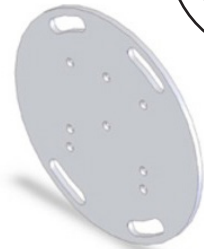

EMBASE LOURDE EML259  
DIAMÈTRE 80CM **60KG**

30 € H.T. / jour

Stock : 6



EMBASE LÉGÈRE TRIANGLE  
ASD EM259AT

3 € H.T. / jour

Stock : 8

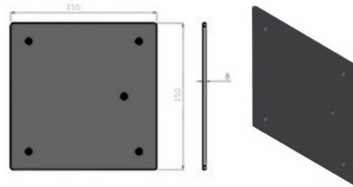

EMBASE LÉGÈRE CARRÉE  
**35X35** NOIRE EM259

6 € H.T. / jour

Stock : 8

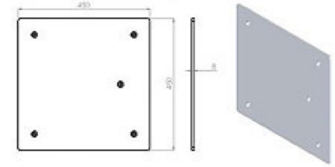

EMBASE LÉGÈRE CARRÉE  
**35X35** ALU EM259

5 € H.T. / jour

Stock : 20



ANGLE VARIABLE ALU

20 € H.T. / jour

Stock : 2

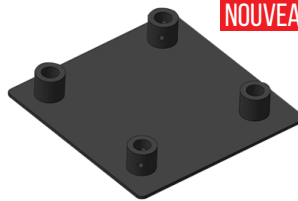

**NOUVEAUTÉ 2023!**

EMBASE LÉGÈRE CARRÉE  
**35X35** NOIRE EM259AC  
MANCHONS FEMELLES

6 € H.T. / jour

Stock : 8

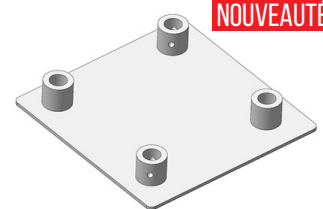

**NOUVEAUTÉ 2023!**

EMBASE LÉGÈRE CARRÉE  
**35X35** ALU EM259AC  
MANCHONS FEMELLES

6 € H.T. / jour

Stock : 8



ANGLE VARIABLE  
NOIR

24 € H.T. / jour

Stock : 2

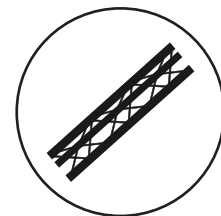

STRUCTURE MONOTUBE



Légende:

ALU      BLACK

EX50029 : 1 € H.T./ Jour	Stock: 4
EX50029 : 2 € H.T./ Jour	Stock: 8
EX50050 : 1 € H.T./ Jour	Stock: 4
EX50050 : 2 € H.T./ Jour	Stock: 8
EX50100 : 2 € H.T./ Jour	Stock: 20
EX50100 : 4 € H.T./ Jour	Stock: 16
EX50150 : 3 € H.T./ Jour	Stock: 10
EX50150 : 5 € H.T./ Jour	Stock: 8
EX50200 : 4 € H.T./ Jour	Stock: 20
EX50200 : 6 € H.T./ Jour	Stock: 4
EX50300 : 8 € H.T./ Jour	Stock: 20



PIED GRAVITY LS431  
NOIR ET BLANC

10 € H.T. / jour

**NOIR**      Stock: 20 ↑

**BLANC**      Stock: 8 ↑

NOUVEAUTÉ 2023!



ANGLE EX5033

3 € H.T. / jour

Stock : 6



ANGLE EX5033B

5 € H.T. / jour

Stock : 6 ↑



ANGLE EX5022

2 € H.T. / jour

Stock : 4



ANGLE EX5031

6 € H.T. / jour

Stock : 4



CUBE 6 FACES  
M10

5 € H.T. / jour

Stock : 10

ÉCHAFAUDAGE



H.TRAVAIL: 4.80M

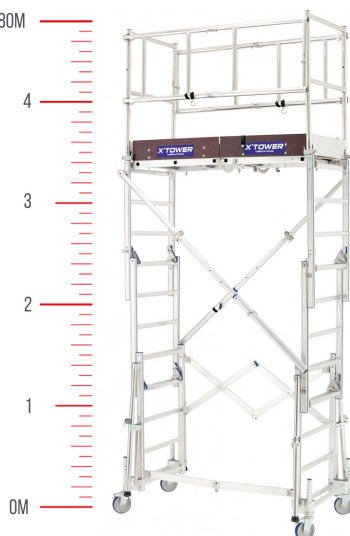

ÉCHAFAUDAGE  
TÉLESCOPIQUE  
XTOWER

80 € H.T. / jour

NOUVEAUTÉ 2023!

Stock : 1





# JONCTIONS

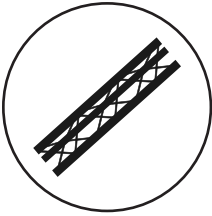

BOÎTE DE **96** MANCHONS / MOYEUX ASD GOUPILLES & SÉCURITÉS

30 € H.T. / jour

Stock : 2



BOÎTE DE **48** MANCHONS / MOYEUX ASD GOUPILLES & SÉCURITÉS

15 € H.T. / jour

Stock : 2



BOÎTE DE **24** MANCHONS / MOYEUX ASD GOUPILLES & SÉCURITÉS

8 € H.T. / jour

Stock : 6

# LEVAGE FANTEK®



PIED À CRÉMAILLÈRE **4,5M**  
CHARGE MAX **120KG**

29 € H.T. / jour

Stock : 4



PIED À FOURCHE **6M** FT 6033  
FANTEK CHARGE MAX **330KG**

60 € H.T. / jour

Stock : 2



T DE STRUCTURE  
ASD

5 € H.T. / jour

Stock : 4

# LYCRAS



LYCRA NOIRE



LYCRA BLANC

CARRÉ



LYCRA 1M

6 € H.T. / jour

TRIANGLE



5 € H.T. / jour

LYCRA 2M

12 € H.T. / jour

CARRÉ



LYCRA 1M

6 € H.T. / jour

TRIANGLE



5 € H.T. / jour

LYCRA 2M

12 € H.T. / jour

5 € H.T. / jour



02.50.50.50.82



contact@solutiontechniqueevenement.com



# ACCROCHE ET LEVAGE

**NOUVEAUTÉ 2023!**

## PINGES IPN



PINCE IPN TYPE CRABE CMU 3 TONNES **(80-320MM)**

8 € H.T. / jour

Stock : 10



PINCE IPN TYPE CRABE CMU 1 TONNE **(80-240MM)**

5 € H.T. / jour

Stock : 10



SUPPORT D'ACCROCHE POUR PROFILÉ DE CHAPITEAU CMU **150 KG**

5 € H.T. / jour

Stock : 20

## PALAN



PALAN MANUEL À CHÂINE CMU 250KG **HAUTEUR 15M**

20 € H.T. / jour

Stock : 4

## ÉLINGUES ET STEELFLEX

STEELFLEX **(DIRECTIVE 2006/42/CE - NORME DGUV VORSHRIFT 17)**



**2T - 1M** 1 € H.T. / jour Stock: 10

**2T - 1,5M** 1,5 € H.T. / jour Stock: 10

**2T - 2M** 2 € H.T. / jour Stock: 10

## ELINGUES GAINÉES



**1T - 0,5M** 0,5 € H.T. / jour Stock: 10

**1T - 1M** 1 € H.T. / jour Stock: 10

**1T - 1,5M** 1,5 € H.T. / jour Stock: 10

**1T - 2M** 2 € H.T. / jour Stock: 10

**1T - 3M** 3 € H.T. / jour Stock: 10



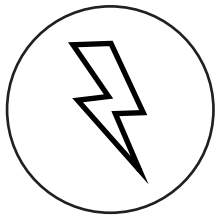

# DISTRIBUTION ELECTRIQUE

**NOUVEAUTÉ 2023 !**



## GAMME INTÉRIEURE (NON IP)



**32A - 13\*PC16A**

**30 € H.T. / jour**

Stock : 4



**63A - 4\*PC32A OUT**

**40 € H.T. / jour**

Stock : 1



**32A IN OUT 6\*PC16A**  
(Attention, pas de disjoncteur 30 milliampères en tête)

**15 € H.T. / jour**

Stock : 4



## GAMME IP EXTERIEUR/INTÉRIEURE



**32A - IN OUT 6\*PC16A**

**40 € H.T. / jour**

Stock : 2



**63A - IN OUT 6\*PC16A - 2\*32A**

**60 € H.T. / jour**

Stock : 1

### CÂBLAGE



**KR2** 5 € H.T. / jour

(2 RALLONGES 10M / 2 RALLONGES 5M / 2 RALLONGES 3M / 2 MULTIPRISES 5P / 2 MULTIPRISES 3P)

**KR5** 10 € H.T. / jour

(5 RALLONGES 10M / 5 RALLONGES 5M / 5 RALLONGES 3M / 5 MULTIPRISES 5P / 5 MULTIPRISES 3P)

**KR10** 20 € H.T. / jour

(10 RALLONGES 10M / 10 RALLONGES 5M / 10 RALLONGES 3M / 10 MULTIPRISES 5P / 10 MULTIPRISES 3P)

**KR100** 30 € H.T. / jour

(4 RALLONGES 25M / 10 RALLONGES 10M / 5 RALLONGES 5M / 5 RALLONGES 3M / 5 MULTIPRISES 5P / 5 MULTIPRISES 3P)

### RALLONGE 32A



**5 M** 5 € H.T. / jour

Stock: 8

**10 M** 7 € H.T. / jour

Stock: 12

**25 M** 15 € H.T. / jour

Stock: 8

### RALLONGE 63A



**10 M** 10 € H.T. / jour

Stock: 2

**25 M** 25 € H.T. / jour

Stock: 1



02.50.50.50.82



contact@solutiontechniqueevenement.com



# BAR À VINYLES



1. JE CHOISIS MON VINYLE



2. JE POSE MON VINYLE



3. JE DANSE SUR MON VINYLE

Imaginez cet ensemble en guise d'animation ludique, collective et collaborative pour votre événement. Le principe est simple : **Rassembler les générations et faire découvrir (ou rappeler) les vertus du vinyle, tout en laissant votre public devenir maître des platines.**

À votre disposition, un ensemble de plus de 500 vinyles 33 et 45 tours triés sur le volet, des classiques indémodables aux nouveautés intemporelles, deux platines vinyles, une enceinte et un décors vintage qui sublimeront votre événement !

400 € H.T. / jour\*

\* Tarif affiché hors transport et hors animateur / technicien.

☎ 02.50.50.50.82

*Ste*

✉ contact@solutiontechniqueevenement.com

**48**





# DIVERS

## PUPITRE JB



**PUPITRE DE CONFÉRENCE JB  
(ATTENTION MICROS NON INCLUS)**

149 € H.T. / jour

Stock : 2

## CONFETTIS



**CANON À CONFETTIS MAGIC FX  
DÉCLENCHEMENT ÉLECTRIQUE  
CONSOMMABLE INCLU**

Vente: 15 € H.T.

## PASSAGE DE CÂBLES



**PASSAGE DE CÂBLES 2 VOIES  
1M**

12 € H.T. / jour

Stock : 40



**PASSAGE DE CÂBLES 1 VOIE  
LÉGER 1M/NOIR**

5 € H.T. / jour

Stock : 50



02.50.50.50.82



contact@solutiontechniqueevenement.com





# CONSOMMABLES

## LIQUIDES

LIQUIDE À CO2

**5L** Vente: 23 € H.T.

LIQUIDE ISOPAR FLAME BLAZER

**5L** Vente: 60 € H.T.

LIQUIDE FLAMANIAC ÉTHANOL

**2,5L** Vente: 45 € H.T.

LIQUIDE À FUMÉE LOURDE À EAU

**2,5L** Vente: 15 € H.T.

## POUDRE DE SPARKULAR



VENTE POUDRE PARKULAR 50G

**20 € H.T. / 50G**

 Environ **3 minutes** d'utilisation.  
1 sachet par machine.

## PAPIER BORNE SELFIE & MIROIR PHOTO



VENTE KIT PAPIER & ENCRE

**100 € H.T. / 400 tirages**

## MACHINE À FUMÉE LOURDE



GLACE CARBONIQUE

**05 KG** 35 € H.T.      **30 KG** 110 € H.T.

**10 KG** 54 € H.T.      **40 KG** 140 € H.T.

**20 KG** 80 € H.T.

## CO2 LIQUIDE

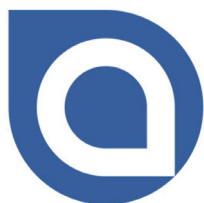

**Air Liquide**

Solution Technique Evènement est dépositaire d'un **contrat Air Liquide** pour la distribution de **CO<sub>2</sub> sous forme liquide**.



**BOUTEILLE DE CO2 LIQUIDE**

**10 KG** 60 € H.T.



**LIVRAISON CO2.**

Tarif fixe pour la livraison CO2, depuis notre fournisseur à notre dépôt situé 27ter rue du Marais, 14 000, Caen pour **1 à 10 bouteilles**.

**25 € H.T.**

 02.50.50.50.82

*Ste*

 [contact@solutiontechniqueevenement.com](mailto:contact@solutiontechniqueevenement.com)

**50**



Ste

---

CONTACTEZ-NOUS !

---



**HORAIRES D'OUVERTURE**

Du lundi au vendredi  
de 10h à 12h  
et de 14h à 19h

Samedi (sur RDV)  
Dimanche fermé



**NOUS TÉLÉPHONER**

02 50 50 50 82



**NOUS ÉCRIRE**

contact@solutiontechniqueevenement.com



**NOTRE ADRESSE**

27 ter, rue du Marais  
14000 CAEN



**NOTRE SITE INTERNET**

[www.solutiontechniqueevenement.fr](http://www.solutiontechniqueevenement.fr)

SUIVEZ NOUS !

